

## ジョイントキャリアー

RoHS対応

ERON®

JOINTS FOR DRILL BUSH CARRIERS No.E-1314

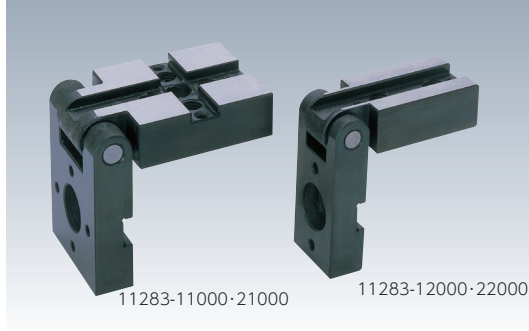

材質 SCM420

熱処理 焼入 HRC60

表面処理 黒染め

- ドリルブッシュキャリアー・プレートジグキャリアーなどのアタッチメントです。
- ワークを取付けたり、取外したりする作業が素早くできます。

▽▽ (▽▽▽)

11283-11000, 21000

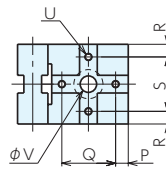
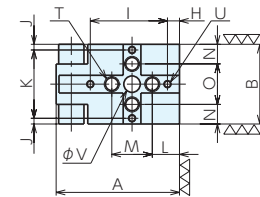

11283-12000, 22000

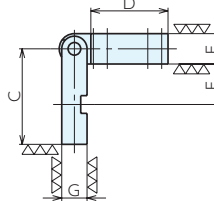
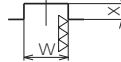
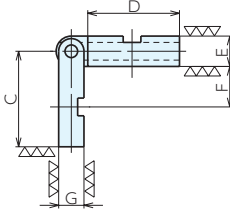
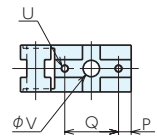
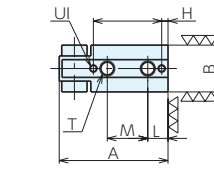

## 仕様・価格表

\* 在庫限りで廃番

オーダーNo.	No.	溝巾	A	B	C	D	E	F	G	H	I	J	K	L
* 125069	11283-11000	10	73	47	56.5	54.5	18	24	15	7.5	45	3.5	40	16
* 125070	11283-12000	10	64.5	27.5	56.5	45.5	18	24	15	4	40	-	-	12
* 125071	11283-21000	14	95.5	63	75.5	72.5	24	25	20	9.5	61	4.5	54	21.5
* 125072	11283-22000	14	74	37	75.5	60.5	24	25	20	5	54	-	-	16

No.	M	N	O	P	Q	R	S	T	U	V	W <sup>H7</sup>	X	質量kg	価格
11283-11000	24	11.5	24	8	31	8	31	M 8	M4	9	10	3.5	0.5	40,500
11283-12000	24	-	-	8	31	-	-	M 8	M4	9	10	3.5	0.3	28,500
11283-21000	32	15.5	32	10	42.5	10	43	M12	M6	13	14	5	1.4	41,300
11283-22000	32	-	-	10	42.5	-	-	M12	M6	13	14	5	0.7	29,300

## 使用例

